

- According to DIN EN 61810-1, DIN EN 61810-3 (Type A)
- With forcibly guided contacts
- Energy efficient; Low energy consumption, because of impulse control, no holding consumption
- Bistable
Mechanical latching of contact position
- Safe separation between all current circuits
- Both coils non-polarised, neutral
- Defined position when both coils are operated simultaneously
- Impulse operation, duty cycle possible (under fault condition)
- Wide temperature range
- As option with manual operation (mechanical indication)
- Washproof (only without manual operation)
- Height 15.8 mm

Applications

- Railway and signalling applications
- Automation
- Medical devices
- Radio- and telecontrol applications
- Fuel applications
- Process applications

Approvals and Markings



Technical Data

Relay type	OB 5623
1.0 Coil	Interlocking and unlocking
1.1 Nominal voltage	DC 6; 12; 24; 48; 60; 110 V ³⁾ (others on request)
1.2 Nominal consumption	Approx. 1.2 W Approx. 0.7 W
1.4 Pulse length	≥ 200 ms
1.11 Voltage range	0.85 ... 1.2 U _N
2.0 Contacts	
2.1 Contact arrangement	4 NO / 4 NC (other on request)
2.2 Contact material	AgSnO ₂ + 0.2 μm Au; AgNi + 0.2 μm Au, AgNi + 5 μm Au
2.3 Rated insulation voltage	AC 250 V
Switching voltage min./max	AC/DC 10 V / DC 250 V, AC 400 V (AC/DC 2 V / 60 V) ⁷⁾
2.4 Limiting continuous current I _{th}	7 x 8 A ⁸⁾ (see Operating voltage limit curve)
Switching current min./max	10 mA ⁶⁾ / 8 A (2 mA / 0.3 A) ⁷⁾
2.5 Switching power min./max	0.1 VA ⁶⁾ / 2000 VA (10 mVA / 12 VA) ⁷⁾
Switching power min./max	0.1 W ⁶⁾ / 200 W (10 mW / 12 W) ⁷⁾
2.6 Switching capacity to IEC/EN 60947-5-1	
AC 15 ⁹⁾	NC: AC 230 V / 3 A NO: AC 230 V / 2 A
AC 15 ²⁾	NC: AC 230 V / 5 A NO: AC 230 V / 2 A
DC 13 ⁹⁾	NC: DC 24 V / 2 A NO: DC 24 V / 2 A
to UL 508	B300 / R300
2.7 Electrical life	At 1 s On, 4 s Off (see contacts service life)
at AC 230 V, 8 A, cosφ = 1	> 10 ⁵ switching cycles AgNi
at DC 24 V 8 A ohmic	> 0.75 x 10 ⁵ switching cycles AgNi
2.8 Switching frequency max	2 switching cycles/s
2.9 Response time ⁴⁾ / Release time ⁵⁾	Typically 20 ms / Typically 12 ms
2.10 Contact force	≥ 8 cN
2.14 Contact gap	> 0.5 mm ¹⁾
3.0 Other	
3.1 Mechanical life	10 x 10 ⁶ switching cycles
3.2 Temperature range	- 40 ... + 75 °C
3.3 Degree of protection, housing	Wash proof RT III, solder line proof RT II (with manual operation)
3.4 Test procedure	A (group mounting)
3.5 Vibration resistance	10 ... < 60 Hz; 0.35 mm Amplitude IEC/EN 60068-2-6 60 ... 200 Hz; ≤ 4 g (all contacts) IEC/EN 60068-2-6
3.6 Climate resistance	40 / 075 / 04; A / B / D IEC/EN 60068-1
3.7 Short circuit strength	1 kA / AC 250 V IEC/EN 60947-5-1 ^{2) 9)}
SCPD / Fuse	NO contact: 10 A gG / gL / NC contact: 6 A gG / gL IEC/EN 60269-1 ^{2) 9)}

¹⁾ Over entire service life acc. to DIN EN 61810-3
⁴⁾ Interlocking
⁷⁾ Typical values for AgNi-contacts + 5 μm Au

²⁾ Values for AgSnO₂-contacts
⁵⁾ Unlocking
⁶⁾ See notes

³⁾ Only impulse operation
⁶⁾ Typical values
⁹⁾ Values for AgNi-contacts

Technical Data

3.8	Insulation acc. to IEC 60664-1, EN 50178	OB 5623 (interlocking)	OB 5623 (unlocking)
	Rated insulation voltage	AC 250 V	AC 250 V
	Pollution degree	2	2
	Overtoltage category	III	III
	Test voltage		
	Contact - coil (1 min)	≥ AC 4 kV eff.	≥ AC 4 kV eff.
	Contact - contact (1 min)	≥ AC 4 kV eff.	≥ AC 4 kV eff.
	Contact open (1 min)	≥ AC 1.5 kV eff.	≥ AC 1.5 kV eff.
	Transient voltage		
	Contact - coil (1.2 - 50 μs)	≥ 6 kV	≥ 6 kV
	Clearance and creepage distance	≥ 5,5 kV	≥ 4,5 kV
3.9	Weight	Approx. 47 g	
4.0	Packing unit		
4.1	On cardboard in slipcase	10 pieces	
4.2	In case package	100 pieces	
5.0	Solder method		
5.1	Solder method /-temperature /-duration	Wave soldering / 260 °C / 5 s	

Function Diagram

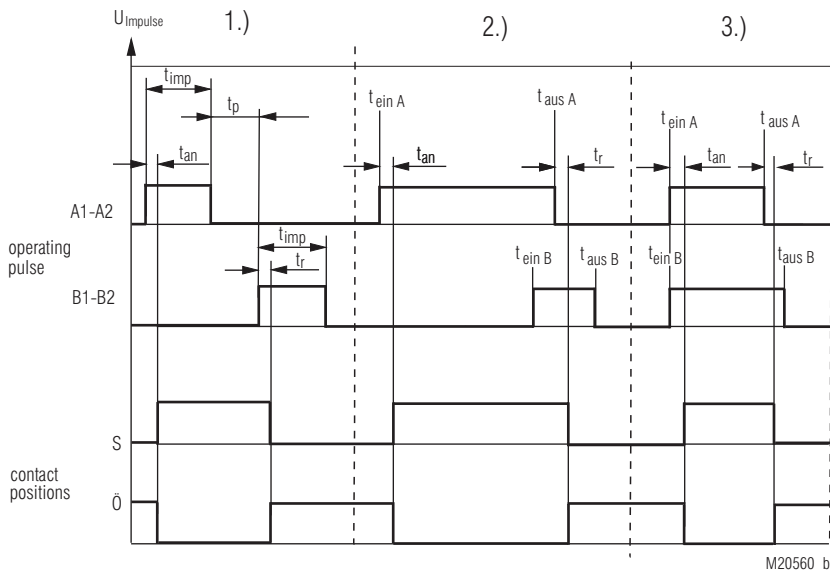

Remark to function

Normal operation

1.) Impuls operation

$$t_p \geq 220\text{ms}$$

Special cases

2.) Interlock-free operation

$$t_{\text{off B}} > t_{\text{off A}} + t_r$$

$$t_{\text{on B}} < t_{\text{off A}} - t_r$$

3.) simultaneous control

$$t_{\text{on A}} = t_{\text{on B}} \text{ permissible; contacts switch}$$

impermissible operation

$$t_{\text{off A}} = t_{\text{off B}}$$

$$t_{\text{aus B}} > t_{\text{aus A}} + t_r$$

t_{on} = switch on point

t_{off} = switch off point

t_{an} = response time (Technical Data 2.9)

t_r = release time (Technical Data 2.9)

t_p = min off time or switch over time

t_{imp} = pulse length (Technical Data 1.4)

Ordering Example

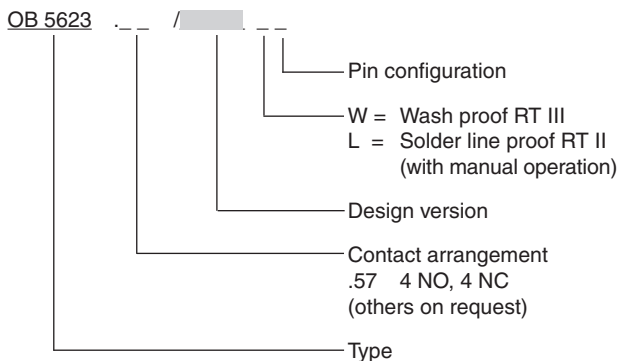

Notes

For the use and processing of our PCB relays, please refer to the **application and processing instructions** at www.dold.com

Design versions

OB 5623 with manual operation				
		interlocking	unlocking	OB 5623
U_N (DCV)	Voltage range (DC V)	R_{Coil} $\Omega \pm 10\%$	R_{Coil} $\Omega \pm 10\%$.57
				4NO, 4NC
AgNi-contacts + 0.2 μ m Au				
6	5.1 ... 7.2	31	52	6001L
12	10.2 ... 14.4	120	200	6002L
24	20.4 ... 28.8	500	750	6003L
48	40.8 ... 57.6	2000	3600	6004L
60	51.0 ... 72.0	2880	4350	6005L
110 ³⁾	93.5 ... 132.0	10100	9216	6006L
AgNi-contacts + 5 μ m Au (gold plated contacts)				
6	5.1 ... 7.2	31	52	6041L
12	10.2 ... 14.4	120	200	6042L
24	20.4 ... 28.8	500	750	6043L
48	40.8 ... 57.6	2000	3600	6044L
60	51.0 ... 72.0	2880	4350	6045L
110 ³⁾	93.5 ... 132.0	10100	9216	6046L
AgSnO ₂ -contacts +0.2 μ m Au				
6	5.1 ... 7.2	31	52	6081L
12	10.2 ... 14.4	120	200	6082L
24	20.4 ... 28.8	500	750	6083L
48	40.8 ... 57.6	2000	3600	6084L
60	51.0 ... 72.0	2880	4350	6085L
110 ³⁾	93.5 ... 132.0	10100	9216	6086L

³⁾ only impulse operation

OB 5623 without manual operation				
		interlocking	unlocking	OB 5623
U_N (DCV)	Voltage range (DC V)	R_{Coil} $\Omega \pm 10\%$	R_{Coil} $\Omega \pm 10\%$.57
				4NO, 4NC
AgNi-contacts + 0.2 μ m Au				
6	5.1 ... 7.2	31	52	6121W
12	10.2 ... 14.4	120	200	6122W
24	20.4 ... 28.8	500	750	6123W
48	40.8 ... 57.6	2000	3600	6124W
60	51.0 ... 72.0	2880	4350	6125W
110 ³⁾	93.5 ... 132.0	10100	9216	6126W
AgNi-contacts + 5 μ m Au (gold plated contacts)				
6	5.1 ... 7.2	31	52	6161W
12	10.2 ... 14.4	120	200	6162W
24	20.4 ... 28.8	500	750	6163W
48	40.8 ... 57.6	2000	3600	6164W
60	51.0 ... 72.0	2880	4350	6165W
110 ³⁾	93.5 ... 132.0	10100	9216	6166W
AgSnO ₂ -contacts + 0.2 μ m Au				
6	5.1 ... 7.2	31	52	6201W
12	10.2 ... 14.4	120	200	6202W
24	20.4 ... 28.8	500	750	6203W
48	40.8 ... 57.6	2000	3600	6204W
60	51.0 ... 72.0	2880	4350	6205W
110 ³⁾	93.5 ... 132.0	10100	9216	6206W

³⁾ only impulse operation

Characteristics

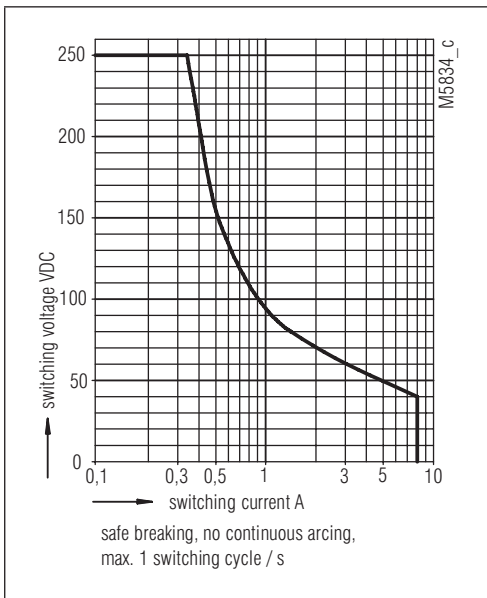
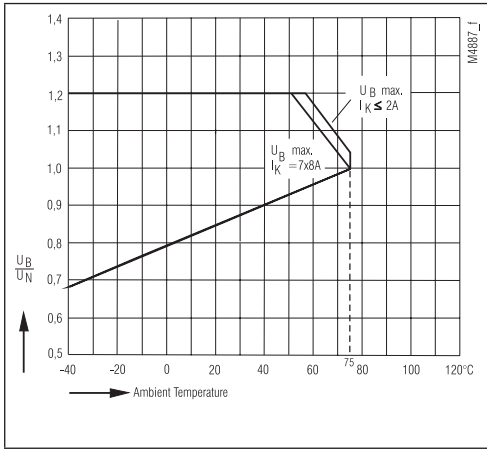

Arc limit curve (load limit curve)

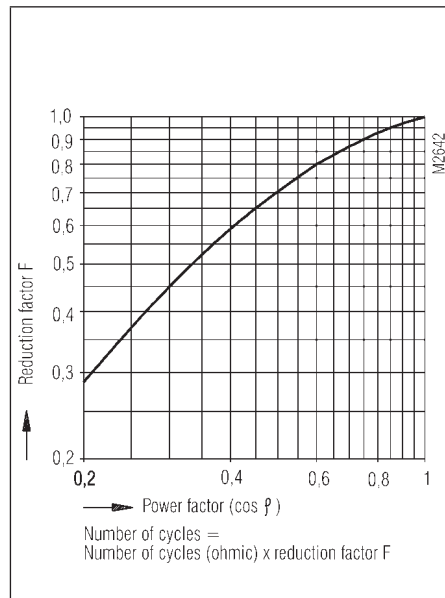

Reduction factor for inductive loads

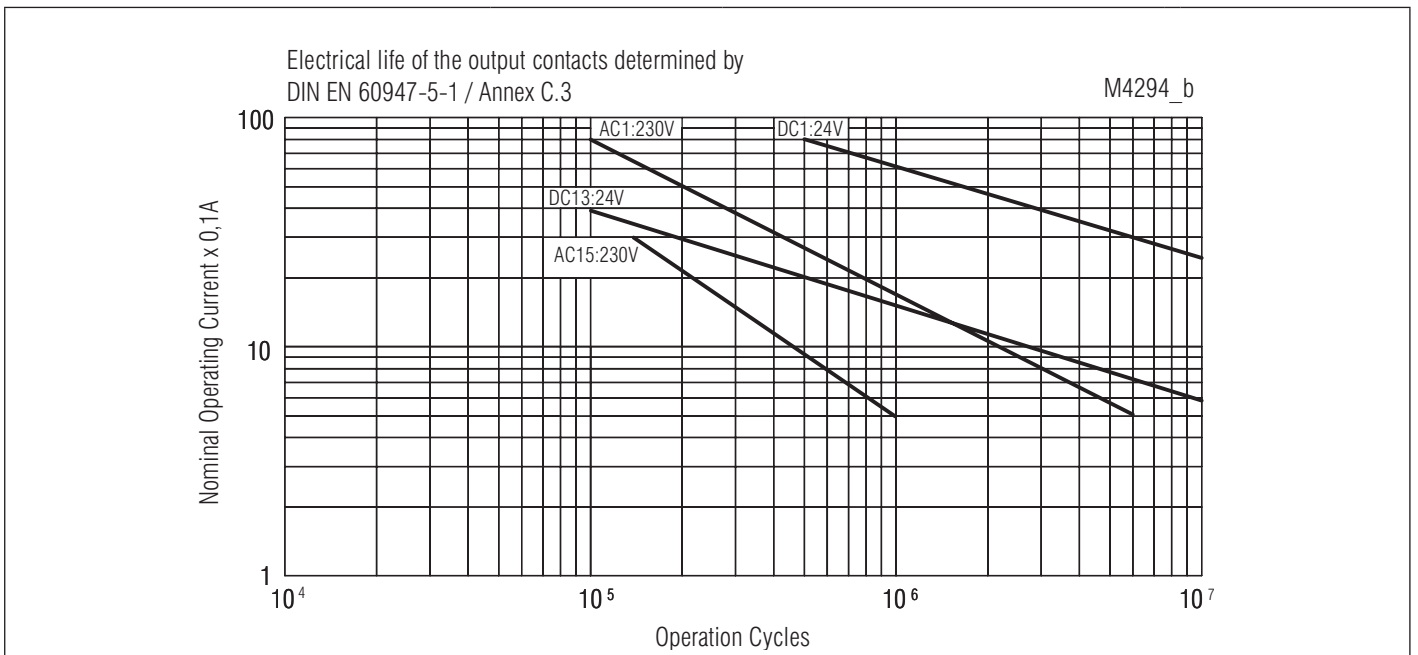

Pin configuration L1 / W1 / L5 / W5

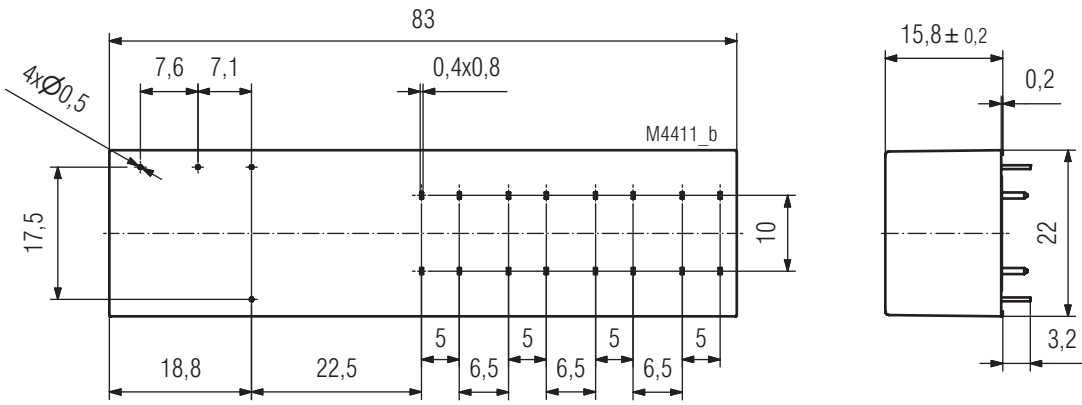

Pin configuration L1 / W1
Drilling plan (solder side)

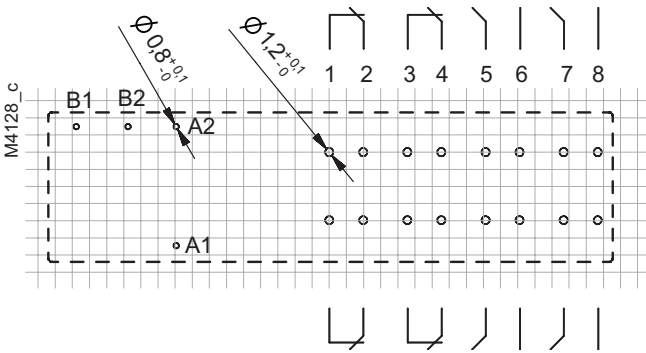

OB 5623.57/___L1 4S/4Ö
OB 5623.57/___W1 4S/4Ö

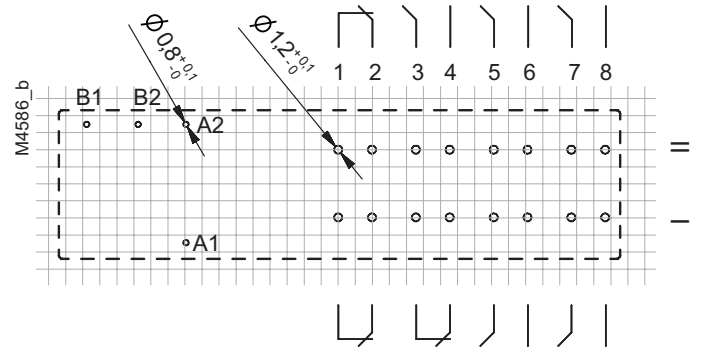

OB 5623.58/___L1 5S/3Ö
OB 5623.58/___W1 5S/3Ö

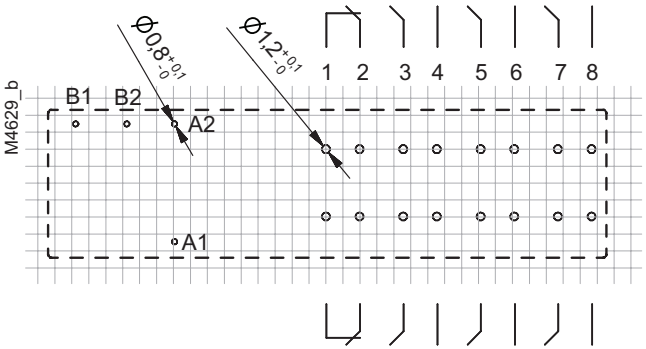

OB 5623.59/___L1 6S/2Ö
OB 5623.59/___W1 6S/2Ö

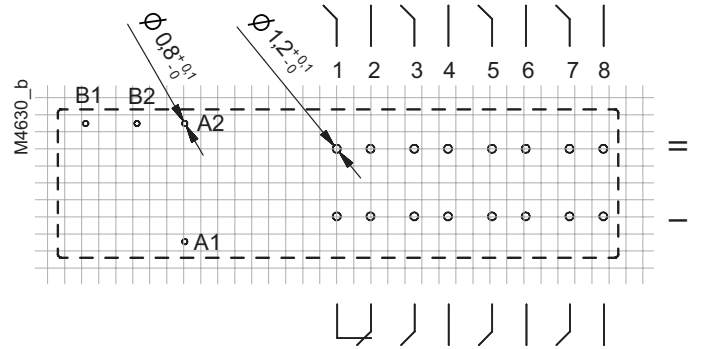

OB 5623.63/___L1 7S/1Ö
OB 5623.63/___W1 7S/1Ö

Pin configuration L5 / W5
Drilling plan (solder side)

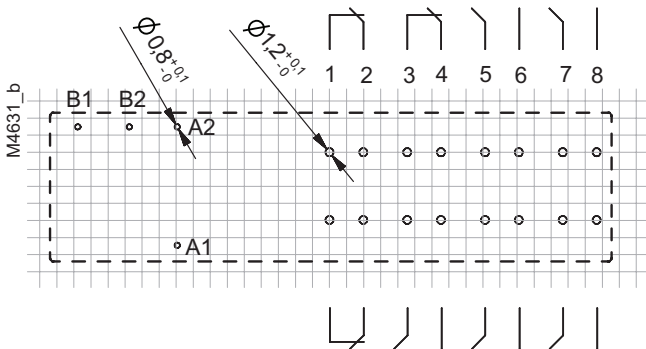

OB 5623.58/___L5 5S/3Ö
OB 5623.58/___W5 5S/3Ö

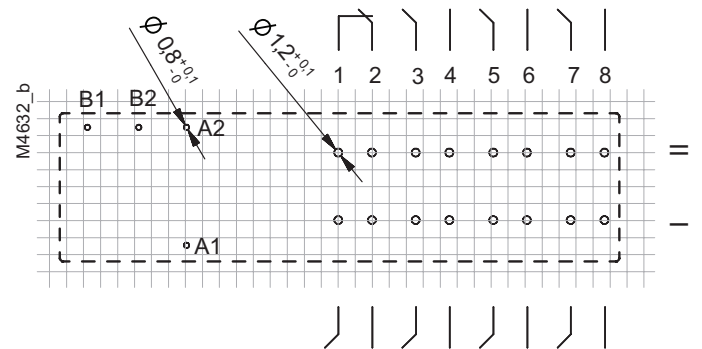

OB 5623.63/___L5 7S/1Ö
OB 5623.63/___W5 7S/1Ö

A: Interlocking; B: Unlocking
Connection for basic grid dimensions 2.50 mm as well as 2.54 mm according to IEC/EN 60097, IEC 60326 average

Pin configuration L7 / W7 / L8 / W8

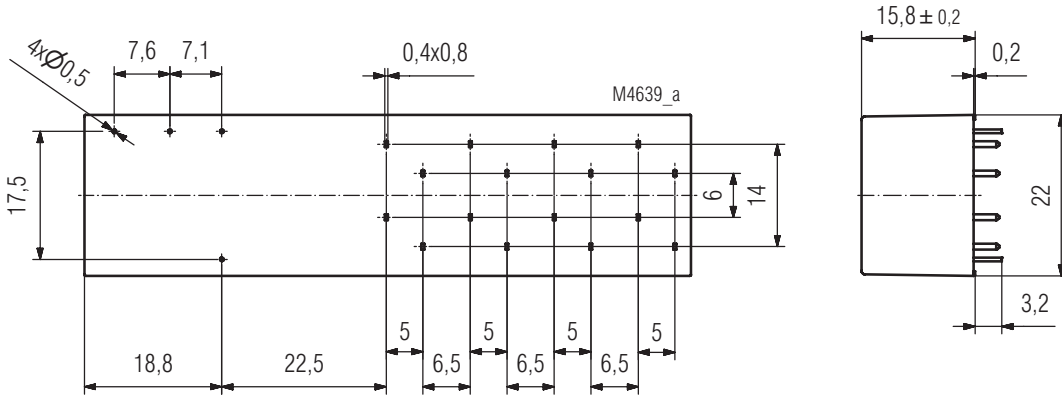

Pin configuration L7 / W7
Drilling plan (solder side)

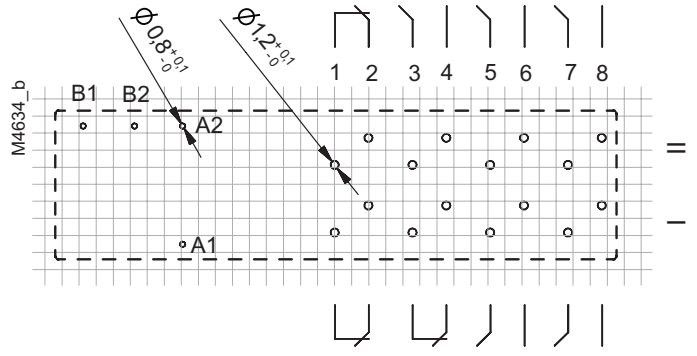
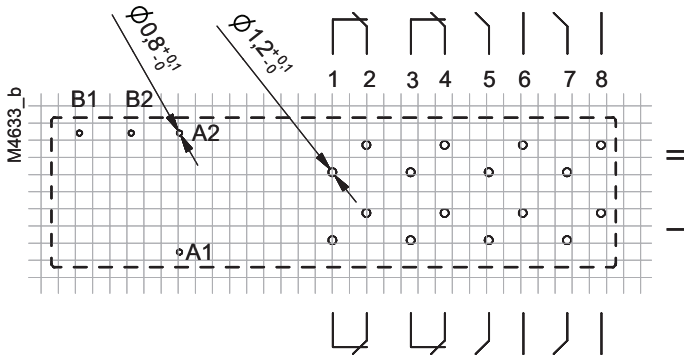

OB 5623.57/___L7 4S/4Ö
OB 5623.57/___W7 4S/4Ö

OB 5623.58/___L7 5S/3Ö
OB 5623.58/___W7 5S/3Ö

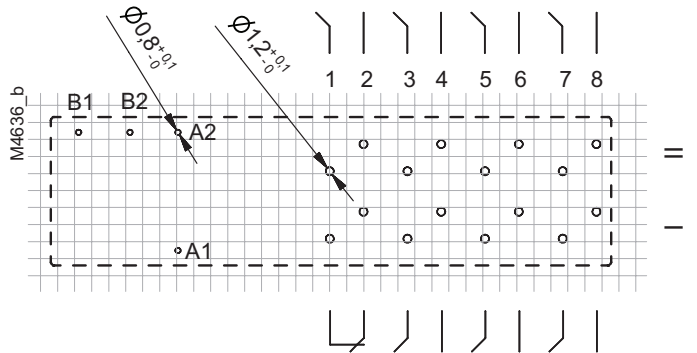
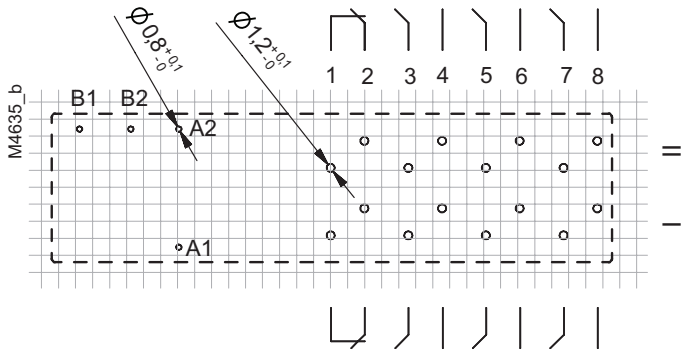

OB 5623.59/___L7 6S/2Ö
OB 5623.59/___W7 6S/2Ö

OB 5623.63/___L7 7S/1Ö
OB 5623.63/___W7 7S/1Ö

Pin configuration L8 / W8
Drilling plan (solder side)

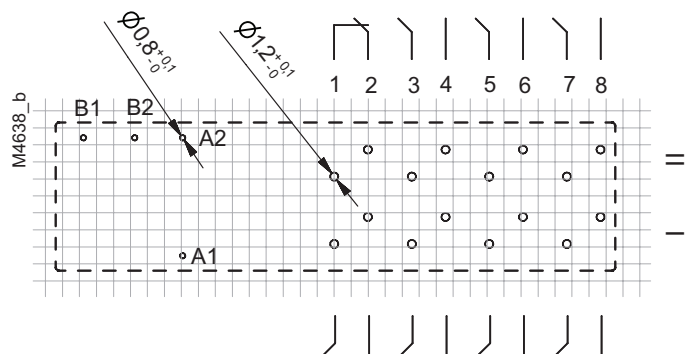
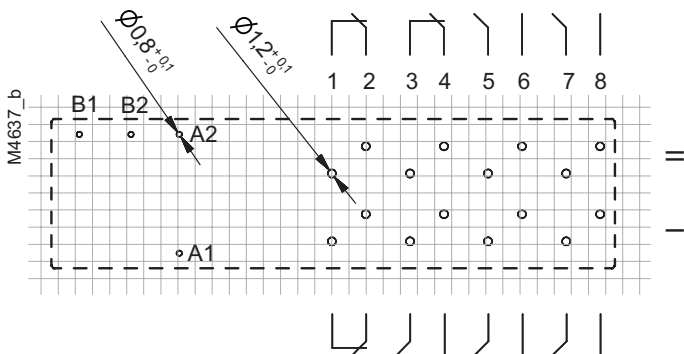

OB 5623.58/___L8 5S/3Ö
OB 5623.58/___W8 5S/3Ö

OB 5623.63/___L8 7S/1Ö
OB 5623.63/___W8 7S/1Ö

A: Interlocking; B: Unlocking
Connection for basic grid dimensions 2.50 mm as well as 2.54 mm according to IEC/EN 60097, IEC 60326 average

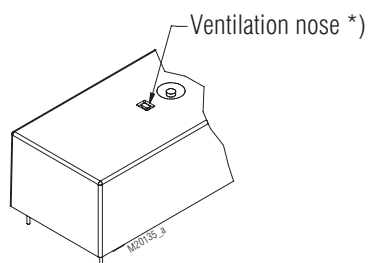

*) When using the maximum switching capacity it is recommended to open the relay without manual operation at the indicated position.

