

POWERSWITCH

Reversing Contactor With Current Monitor BH 9255

Translation
of the original instructions

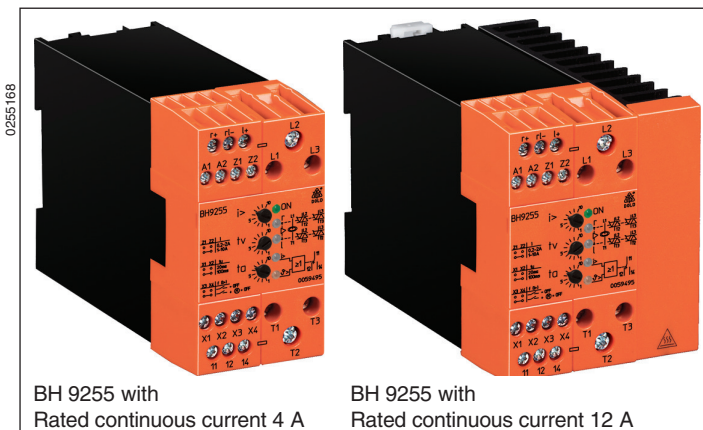

- According to IEC/EN 60947-1, IEC/EN 60947-4-2
- Switching at zero crossing
- To reverse 3 phase asynchronous motors up to 5.5 kW / 400 V (7.5 HP / 460 V)
- Electrical interlocking of both directions
- Temperature monitoring to protect the power semiconductors
- Measured nominal current up to 20 A
- LEDs for status indication
- Galvanic separation between control circuit and power circuit
- With current monitor
- 45 mm; 67.5 mm; 112.5 mm width

Circuit Diagrams

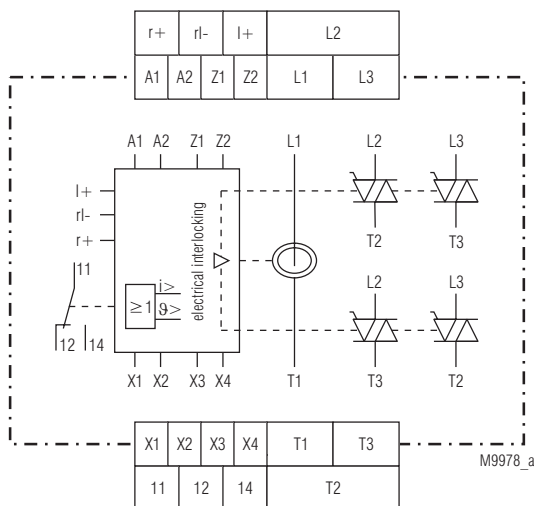

Approvals and Markings



Function

The reversing contactor BH 9255 is used to reverse the direction of 3-phase asynchronous motors by switching 2 phases (L1 and L2). An electrical interlocking disables the control of both directions at the same time. The reversing contactor has a short on and off delay time. When reversing the phases a switchover delay is guaranteed.

The motor current is monitored in phase L1. If the current rises above the tripping value the device is able to switch off the motor

Function

Without bridge x3-x4 (plc control)

After connecting the power supply to A1/A2 the enabling contact 11-14 closes. The motor is now started with a positive edge of the signal on control input r+/r- (clockwise) or l+/l- (anti-clockwise).

The start up delay runs. If the start up delay is finished and the current is still over the adjusted value the relay contacts switch back to 11-12. This state is stored. It resets by switching off the motor on the control input.

If the motor current rises above the adjusted value during operation the time t_v (switching delay) runs down. If the switching delay is finished and the current is still over the adjusted value the relay contacts switch back to 11-12. This state is stored. It resets by switching off the motor on the control input.

With bridge x3-x4 (preferred for manual control)

Same function as without bridge, but in addition to the relay contact 11-12 also the motor is switched off at the same time.

Bridge x1-x2: Switchover delay t_u 20 or 100 ms

Temperature sensing

To protect the power semiconductors the unit incorporates temperature monitoring. When overtemperature is detected e.g. because of reversing to often the power semiconductors switch off and an and the enabling switches back in position 11-12. This state is stored. When the temperature is back to normal the semiconductors can be activated again by switching off and on the control voltage.

Connection Terminal

| Terminal designation | Signal description |
|----------------------|---|
| A1, A2 | Auxiliary voltage |
| r+ / r- | Control input clockwise |
| l+ / l- | Control input anti-clockwise |
| Z1 / Z2 | Parameterization input measuring range via bridge |
| X1 / X2 | Parameterization input switchover delay via bridge |
| X3 / X4 | Parameterization input function via bridge |
| L1, L2, L3 | Mains connection |
| T1, T2, T3 | Motor connection |
| 11, 12, 14 | Contacts output relays, enable- / indicator contact |

Function Diagram

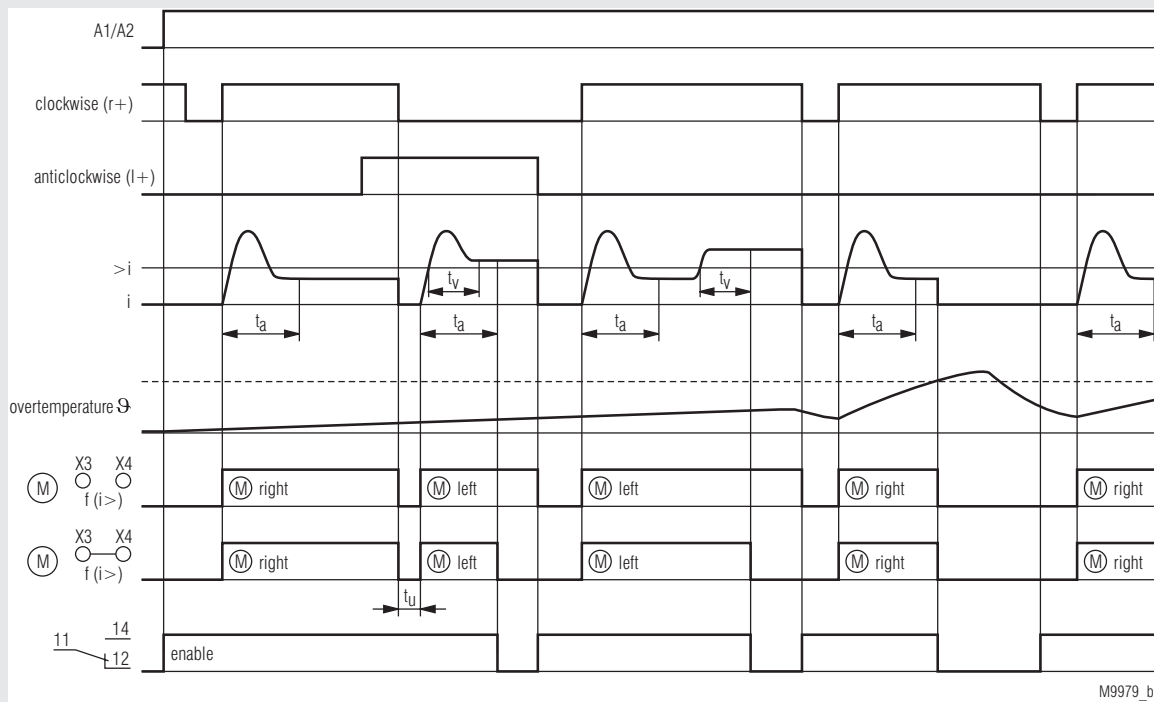

Indicators

| | |
|------------------------------------|--|
| Green LED „ON“ | On when auxiliary supply connected flushes if „t _a “ abläuft |
| Yellow LED „r“ | On, when right direction active |
| Yellow LED „l“ | On, when left direction active |
| Red LED „i>“ | On, when overtemperature and flushes during time elapse of „t _v “ |
| Red LED „ ϑ >“ | On, when overtemperature |
| Both red LEDs „i> + ϑ >“ | Flushes if a system fault is detected. A motor current is measured and while the semiconductors are off. The motor cannot be started. |

Technical Data

Input

Auxiliary voltage U_H : AC/DC 24 V;
AC 110 ... 127 V, AC 230 V, AC 288 V,
AC 400 V (no UL-devices)

Voltage range: AC: 0.8 ... 1.1 U_H
DC: 0.8 ... 1.25 U_H

Nominal consumption
at AC 230 V: 5 VA, 1.1 W
at DC 24 V: 0.6 W

Nominal frequency: 50 / 60 Hz

Control input

r+ /r1 / I+: DC 24 V preferred for plc control
(short response time)
AC/DC 24 ... 80 V
AC/DC 80 ... 230 V

Input

| | DC 24 V | AC/DC 24 ... 80 V AC/DC 80 ... 230 V |
|-----------------|-------------------------------|---|
| Start up delay: | ≤ 10 ms + max. 1 half-wave | ≤ 15 ms + max. 1 half-wave |
| Release delay: | ≤ 10 ms + max. 1 half-wave | ≤ 60 ms + max. 1 half-wave |

Switchover delay t_u : Programmable via bridge on
terminals X1 - X2

Without bridge: 20 ms
With bridge: 100 ms

Start up delay t_s : 0.1 ... 5 s, adjustable via potentiometer

Switching delay t_v : 0.1 ... 5 s, adjustable via potentiometer

Current measuring range: 2 ranges programmable via bridge
on terminals Z1 - Z2

Unit for

measured nominal current

| | 4 A | 12 A | 20 A |
|-------------------------|-------------|-------------|-------------|
| Without bridge Z1 - Z2: | 0.2 ... 2 A | 0.4 ... 4 A | 0.8 ... 8 A |
| With bridge Z1 - Z2: | 1 ... 10 A | 2 ... 20 A | 4 ... 40 A |

other measuring ranges on request

Load Output

| | unit without heat sink | with heat sink width 67.5 mm | with heat sink width 112.5 mm |
|---|--------------------------------|---------------------------------------|--|
| Rated continuous current I_e ¹⁾ [A] | 4 | 12 | 20 |
| Current reduction above 40 °C [A/°C] | 0.1 | 0.2 | 0.2 |
| max. motor power at 400 V [kW] | 1.1 | 4 | 5.5 |
| Nominal motor current I_N [A] | 2.6 | 8.5 | 11.5 |
| max. locked rotor motor current ²⁾ [A] | 15.6 | 51 | 69 |
| Example for max. operat. freq. at 100 % duty cycle, 80 % motor load, starting time t_A 2s, starting current $I_A = 6 \times I_N$ [1/h] | 250 | 210 | 320 |
| Operation mode | AC53a acc. to IEC/EN 60947-4-2 | | |

¹⁾ The rated continuous current I_e is the max. permissible current of the unit in continuous operation.

²⁾ The max. locked rotor motor or starting current of 100 A for 1 s, 85 A for 2 s and 70 A for 5 s must not be exceeded.

³⁾ At $t_A = 1$ s

Note: The max. permissible operating frequency of the motor can be less. See motor data!

Load voltage range: AC 24 ... 480 V

Peak inverse voltage: 1 200 Vp

Frequency range: 50 / 60 Hz

Surge current 10 ms: 350 A

Semiconductor fuse: 610 A²s

Varistor voltage: AC 510 V

Technical Data

Cycle diagram to calculate the operating frequency

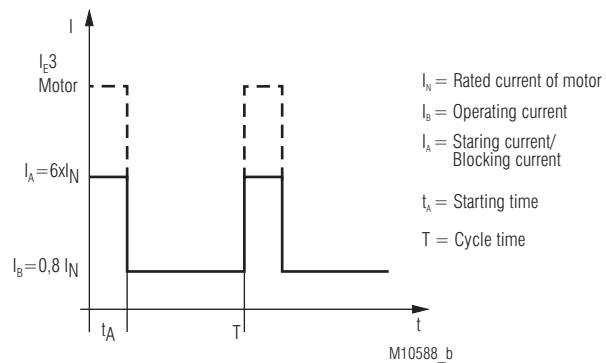

Formula for selection of unit and motor

$$I_e \geq \frac{1}{T} [I_A t_A + I_B (T - t_A)] \quad \text{Device selection}$$

$$I_N^2 \geq \frac{1}{T} [I_A^2 t_A + I_B^2 (T - t_A)] \quad \text{Motor selection}$$

I_A : Starting current / Blocking current

Please take into account the motor data.

Modern motors with efficiency class IE3 may have an inrush peak current of 10-12 times of the nominal motor current.

Monitoring Output

Contacts

BH 9255.11: 1 changeover contact

Thermal current I_{th} : 5 A

Switching capacity

at AC 15

NO: 3 A / AC 230 V IEC/EN 60947-5-1

NC: 1 A / AC 230 V IEC/EN 60947-5-1

Short circuit strength

Max. fuse rating: 4 A gG / gL IEC/EN 60947-5-1

General Data

Operating mode:

Continuous operation

Temperature range

Operation: - 20 ... + 60 °C
Current reduction over 40 °C: see table

Storage: - 25 ... + 70 °C

Altitude: < 2000 m

Clearance and creepage

distances
rated impulse voltage /
pollution degree: 4 kV / 2 IEC 60664-1

EMC

Surge voltages: 5 kV / 0.5 J

Electrostatic discharge: 8 kV (air) IEC/EN 61000-4-2

HF irradiation: 10 V / m IEC/EN 61000-4-3

Fast transients: 4 kV IEC/EN 61000-4-4

Surge voltages between

wires for power supply: 1 kV IEC/EN 61000-4-5

HF wire guided: 10 V IEC/EN 61000-4-6

Interference suppression: Limit value class B EN 55011

Degree of protection:

Housing: IP 40 IEC/EN 60529

Terminals: IP 20 IEC/EN 60529

Housing: Thermoplastic with V0 behaviour

according to UL subject 94

Vibration resistance: Amplitude 0.35 mm IEC/EN 60068-2-6

frequency 10 ... 55 Hz

Climate resistance: 20 / 040 / 04 IEC/EN 60068-1

Terminal designation: EN 50005

Technical Data

Wire connection

Load terminals: 1 x 10 mm² solid or
1 x 6 mm² stranded ferruled

Control terminals: 2 x 2.5 mm² solid or
2 x 1.5 mm² stranded ferruled
DIN 46228-1/-2/-3/-4

Wire fixing:

terminal screws M3.5; box terminals
with self-lifting wire protection

Fixing torque:

Load terminals: 1.2 Nm
Control terminals: 0.8 Nm

Mounting:

DIN rail IEC/EN 60715

Weight:

BH 9255 with 4 A: 460 g
BH 9255 with 12 A: 700 g
BH 9255 with 20 A: 1160 g

Dimensions

Width x height x depth:

BH 9255 with 4 A: 45 x 84 x 121 mm
BH 9255 with 12 A: 67.5 x 84 x 121 mm
BH 9255 with 20 A: 112.5 x 84 x 121 mm

UL-Data

| | unit without heat sink | with heat sink width 67.5 mm | with heat sink width 112.5 mm | | | |
|--|--|---------------------------------------|--|-----|------|-----|
| Switching capacity | | | | | | |
| Relay | | | | | | |
| NO-contact [Vac] | | 230; 3A; GP | | | | |
| NC-contact [Vac] | | 230; 1A; GP | | | | |
| Short circuit current rating [Arms] | | 5000 | | | | |
| Ambient conditions | For usage at pollution degree 2; To be used in circuits that allows a max. current of 5000Arms at 460 V. The device has to be fused with a fuse class RK5 25A. | | | | | |
| Rated continuous current I _e ¹⁾ [A] | 4 | 12 | 20 | | | |
| Ambient temperature [°C] | 40 | 60 | 40 | 60 | 40 | 60 |
| max. motor power at 460 V [HP] | 1,5 | 0,75 | 5 | 3 | 7,5 | 5 |
| Nominal motor current FLA (Full load current) [A] | 3,0 | 1,6 | 7,6 | 4,8 | 11 | 7,6 |
| max. locked rotor motor current LRA [A] | 20 | 12,5 | 46 | 32 | 63,5 | 46 |
| 1) The rated continuous current I _e is the max. permissible current of the unit in continuous operation. | | | | | | |

Wire connection

Load terminals

L1, L2, L3, T1, T2, T3: 60°C / 75°C copper conductors only
AWG 18 - 8 Sol Torque 0.8 Nm
AWG 18 - 10 Str Torque 0.8 Nm

Control terminals

A1, A2, A3, 11, 12, 14: 60°C / 75°C copper conductors only
AWG 20 - 12 Sol Torque 0.8 Nm
AWG 20 - 14 Str Torque 0.8 Nm



Technical data that is not stated in the UL-Data, can be found
in the technical data section.

Standard Type

BH 9255.11 /61 AC 230 V 50 / 60 Hz 4 A AC/DC 80 ... 230 V
Artikelnummer: 0064648
• Output: 1 changeover contact
• Auxiliary voltage U_H: AC 230 V
• Rated continuous current: 4 A
• Control input: AC/DC 80 ... 230 V
• Width: 45 mm

Ordering Example

BH 9255 .11 /61 AC 220...240 V 4 A AC/DC 24 ... 80 V

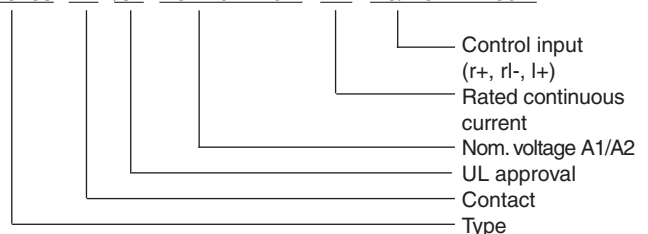

Application Examples

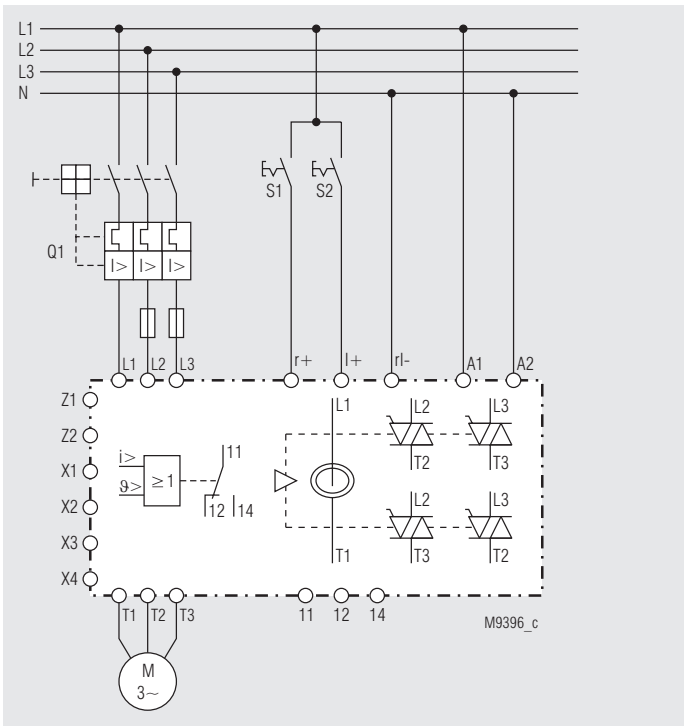

BH 9255 with A1/A2 = AC 230 V and control input AC/DC 80 ... 230 V

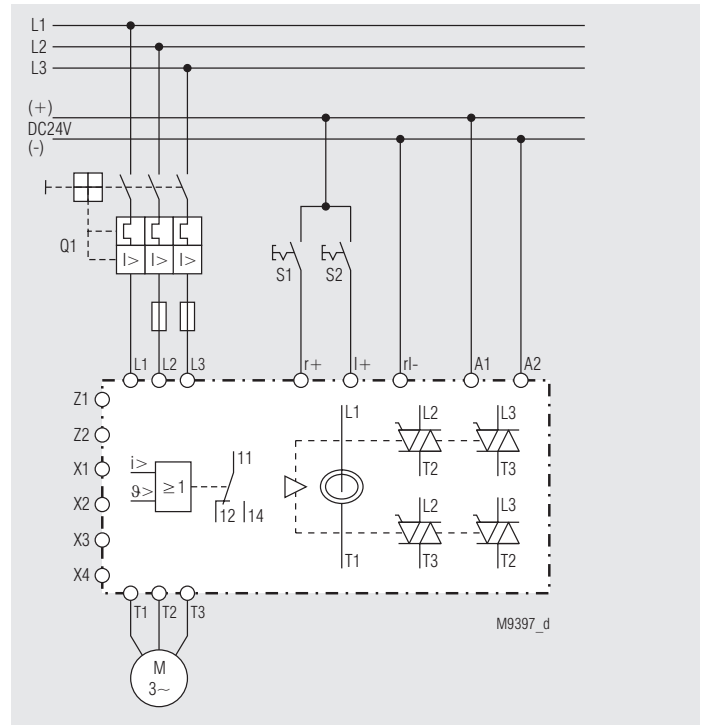

BH 9255 with A1/A2 = AC/DC 24 V and control input AC/DC 24 V or DC 24 V

